

# Is TES the Refrigeration Industries ETS slayer?

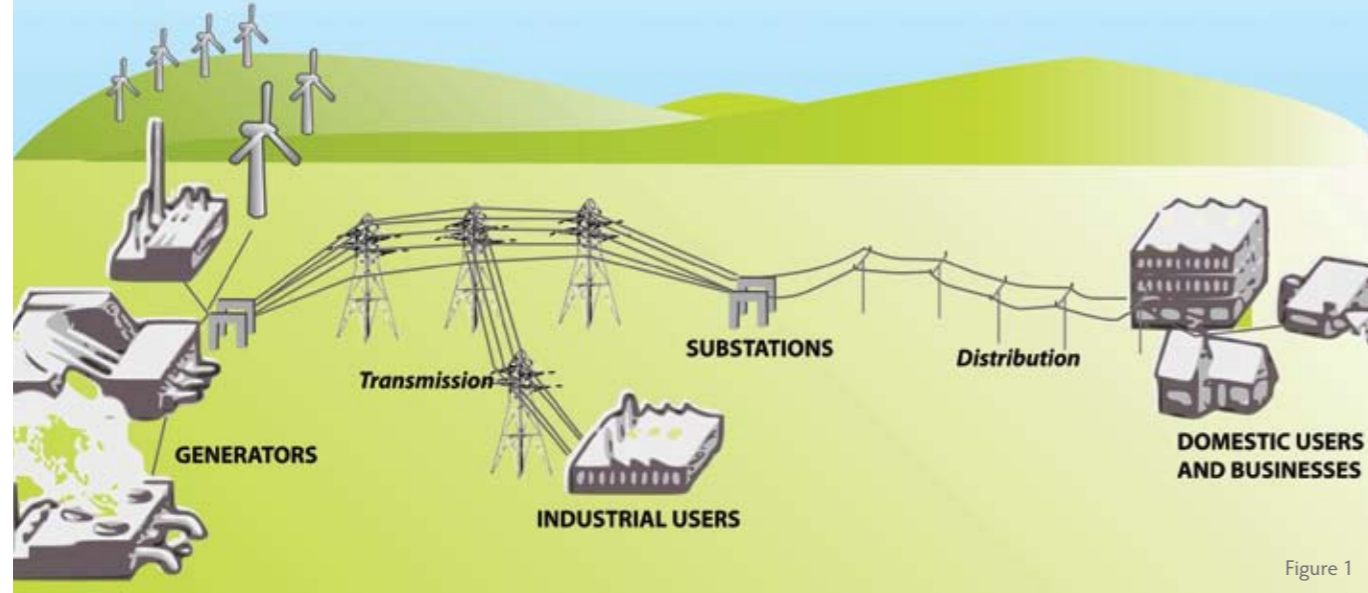

Figure 1

It was good to see so many great articles in the IRHACE May/June 2010 magazine addressing ground sourced heatpumps, refrigerant to hot water and refrigerant recovery systems, forming the basis of energy efficiency issues.

While the implementation of the New Zealand Govt ETS (Emission Trading Scheme) is upon us and we all await its effects on our clients the nation and tax payers, I think it important to remind ourselves why the HVAC industry has such an important role to play in NZ's economic development, especially considering the failed attempts in providing alternate electrical generation systems like Project Aqua and Project Hayes with the associated investigation costs without any gain (10 million on Project Hayes alone).

Running right along with the new generation consent issues is the reliance (Refer figure 3) on gas which supplies 21.9% of our electrical generation, plus our three yearly drought cycle that has an extensive impact on Hydro, the largest source of electrical generation at 56.6% (Refer figure 2) and Figure 3

Under scoring all of this is Maui gas run down (Refer figure 4) which provides such an important component to the way in which New Zealand moves forward in energy creation and conservation. In fact Maui provided such an abundant energy source for so many years that it halted a lot of new generation projects because of its ability to provide such cheap power. Additionally the national transmission grid and distribution network will over the next ten years receive an extensive upgrade at considerable cost.

**Considering the electricity industry generates 7 billion dollars per annum and ETS is a percentage based scheme tied to electricity, gas and fuel costs the potential for our clients to have excessive operating costs based on inefficient, poorly maintained and designed mechanical / hydraulic systems, could essentially expose them and their clients to these excessive operating costs.**

## SO WHAT IS TES AND HOW DOES IT WORK?

TES stands for Thermal Energy Storage and incorporates three methods, namely sensible, (temperature change of a medium with highest

Figure 2

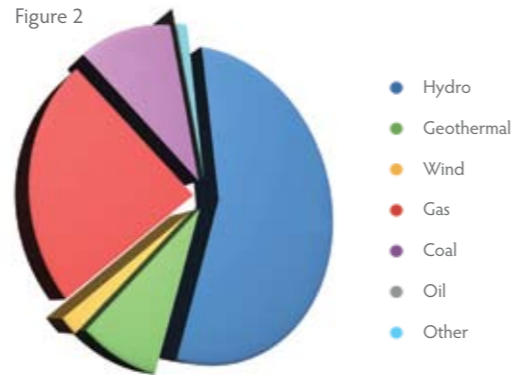
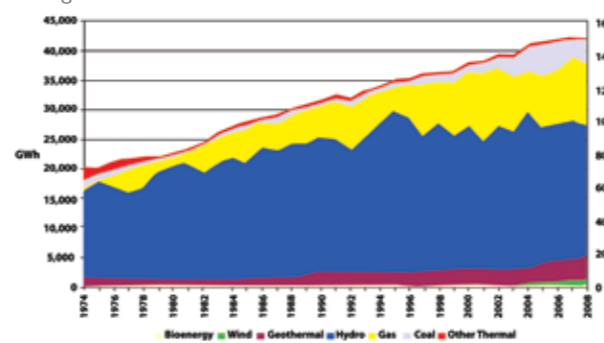

Figure 3



possible heat / cooling capacity) latent (essentially heating / cooling to phase change) and bond (Large amount of chemical energy is absorbed and released)

Anyone interested in researching the various types and their affiliated applications can get excellent information from the following web site [www.energy-storage.org](http://www.energy-storage.org). New Zealand is no stranger to TES, a HANGI is an excellent example of TES in action with the benefits of addressing shock load ie feeding large numbers of people at the same time while allocating a very small cooking area to what would be normally a logistical nightmare.

Figure 4 New Zealand Gas Production and Reserves

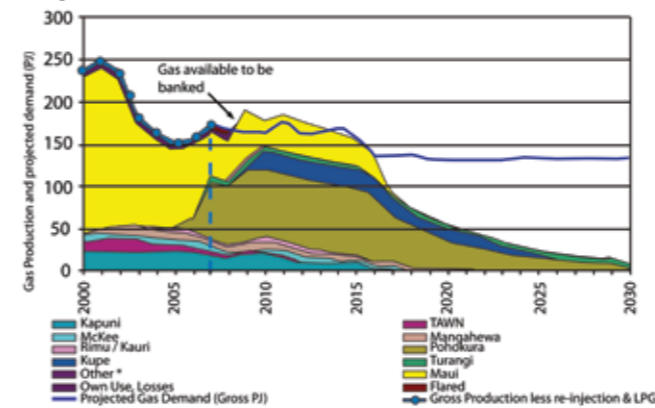

Some of you may also remember the days during the late 70s and early 80s where ECNZ encouraged people to install NIGHT STORES to normally provide background heat for home hallways and bedrooms, the main advantage was to reduce national peak electrical demand during winter (which also meant a reduction of a required new electrical generation program) with the home owner getting the added benefit of over-night cheaper power.

This seemed to be the right angle for energy conservation especially when you see the cost per kW to operate the small alternative generation devices listed below, it endorses the perception that small scale generation is costly with little investor return (unless the cost to get power to site is prohibitive).

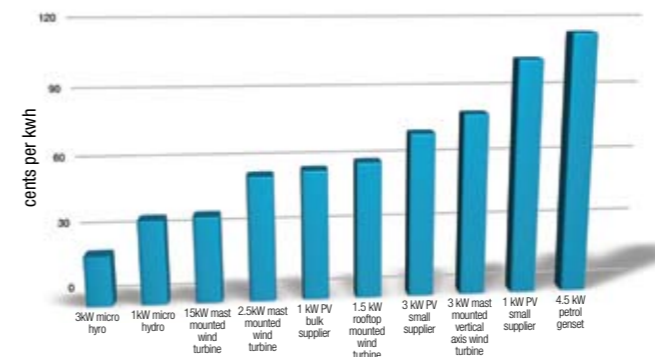

**TES gives the client the opportunity to make full use of renewable, generative, recoverable or co-generative energy saving solutions.** I was lucky enough to be an EECA grant recipient where we were applying a different refrigerant to hotwater recovery technique on a dairy farm, which was monitored by an independent online real time company (Paragon Electronic Design Ltd) and the data reviewed by Canterbury University with an additional onsite blind test.

Additionally we requested Canterbury University to carry out a comparison with traditional on farm heat recovery / generative processes, namely a de-super heater and the Mahana Blue, the results for the de-super heater ranged between 10-32%, the Mahana Blue peaked at 54%. The primary equipment used in our process was the award winning European Eureka Heat Recovery unit that tested out at 61% efficiency, however when we utilized the obvious TES capability of this unit and coordinated the power based on pre production rather than post, the efficiency peaked at 76% with the majority of power consumed outside of national electricity peak demand. Importantly we also noticed a reduction of vat chiller power consumption costs of between 5-8% due primarily to a reduction of condenser fan operation.

The following is the Dairy Farm TES pre production method in action with immersion electric elements previously operating



Committing to the future

**Unbeatable**  
The digital manifold testo 550



**Now only \$613 plus GST**  
Digital manifold including one temperature probe.

A clear win thanks to:

- High and low pressure measurement as well as temperature calculation
- Calculation of superheating/ subcooling in real time
- Robustness and highest ease of operation
- 30 refrigerants are stored in the instrument



People • Technology • Solutions

AUCKLAND : Tel : (09) 579 1990  
WELLINGTON : Tel : (04) 499 3591 CHRISTCHURCH : Tel : (03) 366 0017  
Email : [sales@eurotec.co.nz](mailto:sales@eurotec.co.nz) WEBSITE : [www.eurotec.co.nz](http://www.eurotec.co.nz)

**HVAC • Refrigeration • Electrical • Measurement**

FEATURE

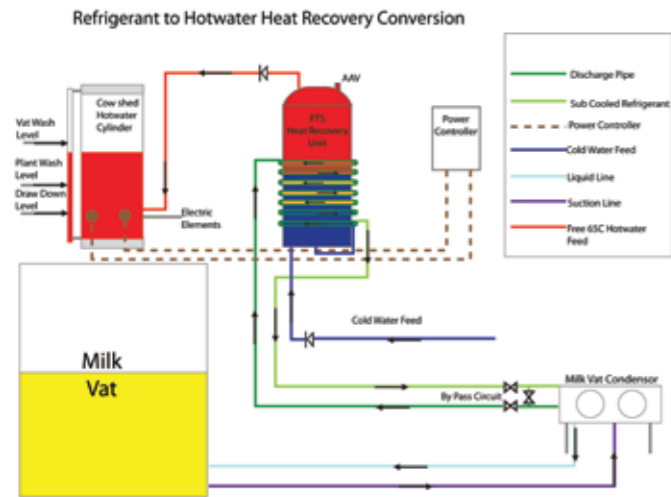
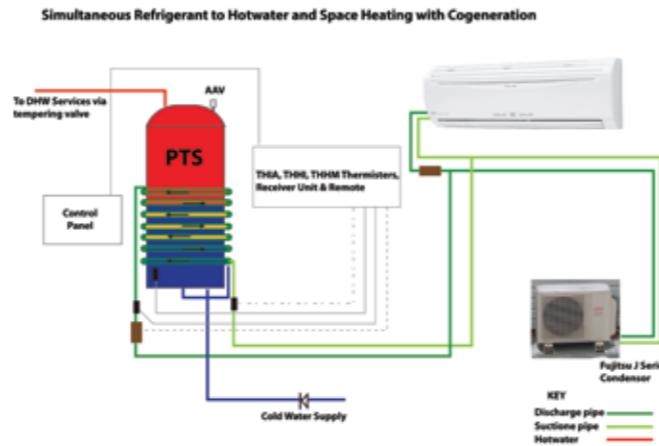
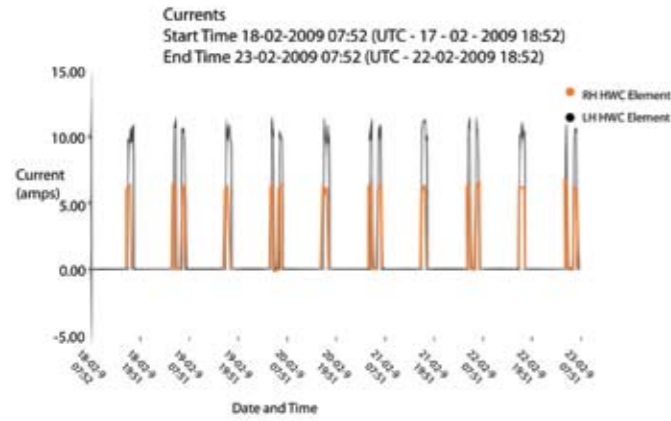

at a total of 7.5 hours a day. An important part of this process is the online real time monitoring through Paragon, that allowed us to select the most efficient method of timing, to ensure confidence for the farmer that the process would work and identified a hydraulic issue that could be easily corrected. It also gave us the ability to use the data to confidently approach the co generation application mentioned below.

TES COMBINED WITH CO GENERATION

In June of 2010 the NZFS (New Zealand Fire Service) released a tender for the DHW and space heating modification at Wellingtons Newtown Fire Station, which was currently being serviced by an old 125 kW converted gas boiler and DHW services via a calorifier.

The system consumed approx 300 kWh of gas per day 7 months of the year and up to 500 kWh per day for the other 5 months. Clearly the NZFS wanted to meet their Govt obligations of energy reduction and address some very serious unsatisfactory onsite DHW pressure / flow concerns by the onsite firemen.

THE SOLUTION

The new Climatemaster design incorporated the dividing of the site into three zones ie Operation, Living and combined Commercial Drying Room / Generation / Co Generation DHW. A selection of highly efficient Fujitsu J Series units were installed to meet the heating / cooling load for the Living area, and the Operation areas had remote sensors that automatically shut that system down on extended delayed presence or emergency call out.

The DHW / Drying Room however incorporated a Fujitsu J Series condenser coupled with a hiwall unit for the Drying Room and interfaced with a standard Fujitsu controller coupled to the Eureka PTS

Recovery unit. Once again online real time monitoring through Paragon and understanding the daily firemen process allowed us to generate DHW prior to primary peak use with the remaining energy being available during a Co Generation process recovering redundant energy from the drying room operation.

**The net result is a 92-94% reduction to an 11 electrical kWh consumption to the previous 300 kWh gas consumption with the total removal of the gas boiler plus an increase in water flow.**

A Summary of combined TES Refrigerant Recovery / Co Generation benefits are:

- 1) Large reduction in energy consumption with the remaining energy being transferred to national grid off peak consumption, which of course reduces the need for expensive new electrical generation.
- 2) Utilisation of the speed that refrigeration systems can generate hotwater for shock load applications like that in Dairying, Hotels, Resthomes, Breweries etc etc
- 3) Reduction in the national grid line losses that occur in over stressed lines during peak demand which equates to loss of Govt revenue.
- 4) Reduction in the amount of energy consumed by high demand dependant industry groups that receive power at 12-18c per kWh and therefore an increase in net profitability and Govt taxable income.
- 5) Large reduction in Government liabilities under the Kyoto Protocol touted in a recent report at being a billion dollars in 2012.
- 6) Processes that can be applied to SME's and assist NZ's primary export sectors ie Agriculture, Horticulture, Aquaculture and Tourism.
- 7) With a payback of 2.5 years the NZFS project is achieving a 40% return on investment with the dividend paid monthly via radically reduced energy bills, given the demise of the investment finance sector and the decreased return from property investment our clients are unlikely to achieve returns as high from this form of secure investment.
- 8) As you can see from the schematic diagrams these concepts, have the potential to create employment to mitigate the losses via a depressed building sector.

Climatemaster would like to acknowledge and thank the following in presenting this article. Ministry of Economic Development for the exerts from the 2009 ministerial report, Paragon Electronic Design Ltd for the independent Online Realtime Monitoring, Fujitsu General for their continued support and use of their test room at Seaview, Assoc Prof Susan Krumdieck Canterbury University and team Climatemaster for their extensive research into the Dairy farm project and EECA for the financial assistance.

# Fujitsu is delighted to announce the WINNER of the inaugural "EXCELLENCE IN INNOVATION" AWARD



Kim Naylor MD of Fujitsu General New Zealand congratulates Rick on winning the inaugural Innovation award

Rick Hudepohl of Climatemaster does more than sell and install heat pumps.

For the past 2 years he has been working on what he calls 'the refrigeration industry's ETS slayer'. It is called Eureka Refrigerant to Hot Water, and it uses a process called TES (which stands for Thermal Energy Storage), for off peak generation (refrigerant to hotwater); Recovery (from cooling based applications and Co-generation – to harvest redundant energy from heating based applications).

Armed with an EECA grant, and partnership help from Fujitsu, EUREKA is now not only viable, but has been successfully tested by Canterbury University and has already been installed and is running in a number applications.

Many Congratulations to Rick and his tenacity, we at Fujitsu salute you, and are delighted to have the opportunity to partner you in this brilliant endeavor.



NEW ZEALAND'S FAVOURITE AIR™